

# TIPS<sup>®</sup> X603 LARGE ANGLE TILT SENSOR

## INTRINSICALLY SAFE FOR HAZARDOUS GAS/VAPOUR ATMOSPHERES

- **Intrinsically safe for Gas to:**  
 **II 1G**
- **Non-contacting inductive technology to eliminate wear**
- **Angle set to customer's requirement**
- **Compact and self-contained**
- **High durability and reliability**
- **Sealing to IP67**



As a leading designer and manufacturer of linear, rotary, tilt and intrinsically safe position sensors, Positek<sup>®</sup> has the expertise to supply a sensor to suit a wide variety of applications.

Our X603 TIPS<sup>®</sup> (Tilt Inductive Position Sensor) is ATEX approved for use in potentially explosive **gas/vapour** atmospheres. It is designed for industrial and scientific feedback applications and is ideal for OEMs seeking good sensor performance for arduous applications in hazardous areas. The X603, like all Positek sensors, is supplied with the output calibrated to the angle required by the customer, between 20 and 160 degrees and with full EMC protection built in. The sensor provides a linear output characteristic with angle of deflection. There is a machined registration mark to identify the calibrated mid point.

Overall performance, repeatability and stability are outstanding over a wide temperature range. Electrical connections to the sensor are made via an industrial standard 4-pin M12 connector, with limited rotational capability to facilitate cable routing.

The sensor has a rugged stainless steel body and anodised aluminium mounting flange. The flange has two 4.5mm by 30 degree wide slots on a 48mm pitch to simplify mounting and position adjustment. Environmental sealing is to IP67.

### SPECIFICATION

#### DIMENSIONS

Body diameter 35 mm  
 Body Length (to seal face) 44 mm

*For full mechanical details see drawing X603-11*

#### Independent linearity/Hysteresis

(combined error) < ± 0.25 degrees

**Temperature coefficients** < ± 0.01%/°C Gain &

< ± 0.01%FS/°C Offset

**Typical overall accuracy** < ± 0.5%/ FSO

**Response time** 250 mS @ 20°C typ.

**Resolution** Infinite

**Damping ratio** 0.2 : 1 (0.6 nom. @ 25°C)

**Noise** < 0.02% FSO

#### Intrinsic Safety

 II 1G

EEx ia IIC T4 (Ta = -40°C to +80°C)

maximum limits Ui: 11.4V, Ii: 0.46A, Pi: 0.51W.

#### Environmental Temperature Limits

Operating -40 to +80°C

Storage -40 to +125°C

**Sealing** IP67

**EMC Performance** EN 61000-6-2, EN 61000-6-3

**Vibration** IEC 68-2-6: 10g

**Shock** IEC 68-2-29: 40 g

**MTBF** 350,000 hrs 40°C Gf

#### Drawing List

X603-11 Sensor Outline

*Drawings, in AutoCAD<sup>®</sup> dwg or dxf format, available on request.*

**Do you need a position sensor made to order to suit a particular installation requirement or specification? We'll be happy to modify any of our designs to suit your needs - please contact us with your requirements.**

# TIPS® X603 LARGE ANGLE TILT SENSOR

## INTRINSICALLY SAFE FOR HAZARDOUS GAS/VAPOUR ATMOSPHERES

Intrinsically safe equipment is defined as "equipment which is incapable of releasing sufficient electrical or thermal energy under normal or abnormal conditions to cause ignition of a specific hazardous atmosphere mixture in its most easily ignited concentration."

ATEX approved to  II 1G EEx ia IIC T4 (Ta = -40°C to +80°C)

Designates the sensor as belonging to; Group II: suitable for all areas **except mining**, Category 1 G: can be used in areas with continuous, long or frequent periods of exposure to hazardous gas (Zone 0).

Protection class ia, denotes intrinsically safe for all zones Apparatus group IIC: suitable for IIA to IIC explosive gas. Temperature class T4: maximum sensor surface temperature under fault conditions 135°C.

Ambient temperature range extended to -40°C to +80°C.

Positek intrinsically safe sensors are designed to be used with a galvanically isolated barrier with safety parameters not exceeding:-

Ui: 11.4V, Ii: 0.46A, Pi: 0.51W.

Sensor can be installed with a cable length up to 150m maximum from the barrier, capacitance and inductance can be up to:-

Capacitance: 550 nF max, Inductance: 99 µH max.

Approved barriers are available from Positek®; there is a choice of 0.5-9.5V or 4-20mA transmission outputs.

0.5-9.5V barrier option - BX002.

4-20mA barrier option - BX003.

ATEX approved sensors suitable for dust (E series) and mining (M series) applications, are also available from Positek.

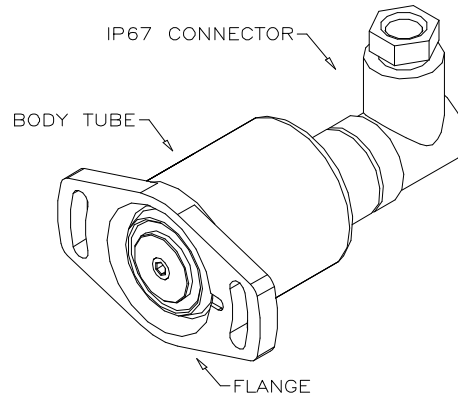

### TABLE OF OPTIONS

**MEASUREMENT RANGE:** Factory-set to any angle from ±10° to ±80° in increments of 1 degree.  
 Full 360° Mechanical rotation.

#### ELECTRICAL INTERFACE OPTIONS

A galvanic isolation barrier is required to meet IS approval - 0.5-9.5V or 4-20mA options, see barrier data sheet overleaf.

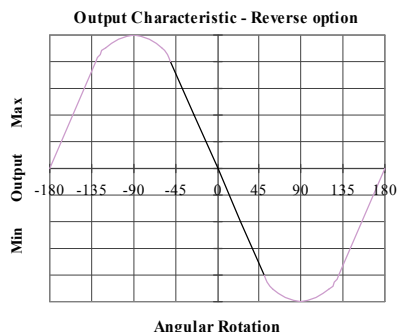
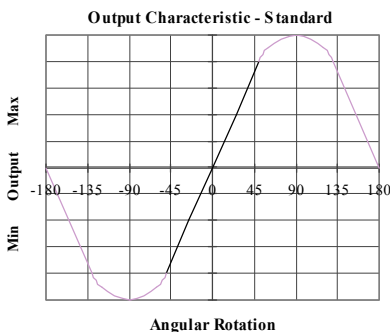

# INTRINSICALLY SAFE BX002 and BX003 Sensor Barrier

Intrinsic safety means limiting the electrical energy in a system to a level incapable of causing ignition in any normal or fault condition. This can only be accomplished by installing an energy-limiting interface in the wiring between hazardous and non-hazardous areas.

Limiting the discharge of energy-stored devices in electrical equipment such as capacitors and inductors virtually eliminates the possibility of generating a spark and thus a source of ignition.

The **BX002** (0.5 to 9.5V) and **BX003** (4 to 20mA) Isolated Galvanic Barriers are the best choice for use with Positek Intrinsically Safe Position Sensors. The hazardous area circuits are certified intrinsically safe [EEx ia] IIC. Connections between hazardous and non-hazardous areas are transformer isolated, eliminating the requirement for a high-integrity intrinsically safe earth.

Choosing either a BX002 or BX003 barrier not only provides signal isolation but allows sensors to be calibrated to a specific barrier type before shipping, ensuring the respective barrier output corresponds to the sensor position over the calibrated range. The isolated power circuit limits the energy supply to the sensor to ensure the maximum safety parameters required for Positek sensors are not exceeded.

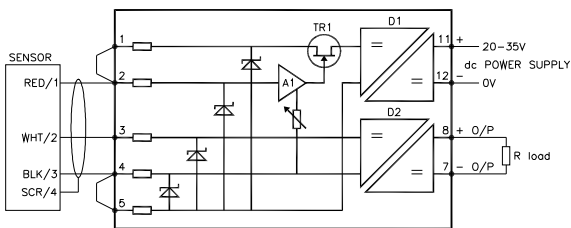

How it works; a 20-35V dc external power supply is connected to the dc/dc converter D1 which provides isolation. The output from D1 is regulated by A1 and TR1 to provide a nominal 5V supply for the sensor. The barrier and sensor can be connected by three wires; 5-wire connection capability is available to compensate for volts drop in long cable runs.

D2 provides isolation between the sensors output and the barriers 0.5-9.5V or 4-20mA current loop output.

- **ATEX approved**
- **Tri-port isolated**
- **DIN rail mounted**
- **Voltage and current output versions**



## SPECIFICATION

**POWER SUPPLY**  
 Voltage 20-35V dc  
 Power consumption ca. 0.7W for voltage output, 1.4W current output

**INPUT CIRCUIT** (terminals 1,2,3,4,5)  
 Transformer isolated  
 Intrinsically Safe [EEx ia] IIC  
 BAS00ATEX7171  
 U<sub>max</sub> out = 10.4V  
 I<sub>max</sub> out = 46mA  
 ca. 4.8 volts  
 12Ω maximum (all connections)  
 17MΩ min

**OUTPUT CIRCUIT** (terminals 7/8)  
 Output options  
 Voltage BX002 0.5 to 9.5V  
 Output resistance < 30Ω  
 Current loop BX003 4 to 20mA  
 Load resistance 0 - 1kΩ

**TRANSFER CHARACTERISTICS**  
 Non-linearity: < ± 5mV for voltage outputs  
 < ± 10μ A for current outputs  
 Temperature drift: < 0.5mV/°C for voltage outputs  
 < 1μA/°C for current outputs  
 Settling time to 1% of span: < 25ms for 10-90% step change  
 Rise time: < 8ms 10-90% of step change  
 Bandwidth dc to 100Hz (-3dB)  
 Isolation: 2500V between safe area terminals and hazardous area terminals, 50V between power rail terminals and output terminals (7 and 8)

**ELECTROMAGNETIC COMPATIBILITY**  
 Emissions: to EN50081-2  
 Immunity: to EN50082-2  
 Ambient temperature range: -20° to 60°C working, -40°C to +100°C storage  
 Protection class IP20